



LED 光纤光源
用户手册

Version 2.1.1

Contents

1	General Overview	3
1.1	LED Fiber Light Sources	3
2	Operations Guide	5
2.1	LED Fiber Light Source Setup	5
2.2	FC Connector Installation	5
2.3	Stand-alone mode (without Doric Neuroscience Studio Software)	6
3	Doric Neuroscience Studio	8
3.1	Light Sources	8
4	Specifications	17
5	Annex 1: Safety Features	19
5.1	Safety Labels	19
5.2	Activation Safety Features	19
5.3	Emission Indicator	20
6	Support	21
6.1	Maintenance	21
6.2	Warranty	21
6.3	Contact us	21

General Overview

1.1 LED Fiber Light Sources

Doric *LED Fiber Light Sources* come in different packages from 1 to 4 channels that can be used stand-alone or with a computer via USB connection. The module has one or more beam apertures, each emitting a different wavelength (Fig. 1.1).



Figure 1.1: LED fiber light sources

Each module contains the following elements:

- The **Beam aperture** (Fig. 1.2) is where the light exits the light source. The aperture is composed of a fiber coupling assembly that injects the emitted light into an optical fiber. The standard model uses an FC fiber connector. A safety FC metal cap is attached to the **Beam aperture** head to block the output light beam in absence of optical fiber.



Figure 1.2: LED fiber light source front

- The **LCD display** allows easy operation and monitoring. The LCD display shows the mode for each channel as well as the constant or maximal current in mA.
- The **Control knob** is used to change the maximum current to the LED, as well as change the operation mode of the system.
- The **Safety key** must be in place to enable module operation. Despite its similar shape, the safety key is not a standard micro SD card such as those used in some digital cameras. Do not attach the Key to a key fob or similar holder; this may prevent proper insertion of the Key Switch.
- The **On/Off** switch turns on and off the light source.



Figure 1.3: LED fiber light source rear elements

- The **Interlock connector plug** (Fig. 1.3) allows the user to connect the USB-B Connector to an interlock system. It is recommended to connect the interlock plug to a laboratory interlock system. This is critical when using LEDs in the UV or Infrared spectrum, as they are invisible to the naked eye.
- The **Input BNC** allows external analog signals to control each individual light source.
- The **Output BNC** are used to monitor the current on each LED.
- The **12 VDC power input** connects the module to its 12 VDC power supply.
- The **USB-B connector** allows the module to be connected to a computer using a USB-A/USB-B cable.

Operations Guide

2.1 LED Fiber Light Source Setup

1. Connect the **LED Fiber Light Source** to the **12 VDC Power Supply**.
2. For optimal performances, place the module in a well ventilated area, especially if used in continuous mode for long period of time. Overheating will affect LED power and reduce its lifetime.
3. The *LED Fiber Light Source* is operated with the driver's stand-alone capabilities (Section 2.3) or using the *Doric Neuroscience Studio* software (Section 3.1).

2.2 FC Connector Installation

1. Clean the optical fiber connector before insertion. Use isopropanol and a lint-free wipe.
2. With an FC connector, the connector key must be oriented to enter within the receptacle slot to ensure proper connection (Fig. 2.1).

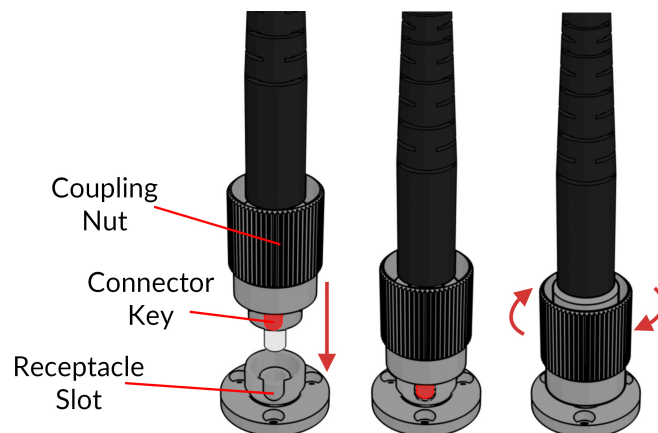

Figure 2.1: FC connector, Fiber Installation

⚠ To reduce the risk of eye injury, it is sound practice to NOT CONNECT/DISCONNECT OPTICAL FIBERS when the light source is turned on.

2.3 Stand-alone mode (without Doric Neuroscience Studio Software)

The following sections details stand-alone operation of the *LED Fiber Light Source*.

2.3.1 Driver operation modes with the stand-alone device

If the light source driver is used as a stand-alone device, 3 modes are available: constant current (CW), external TTL (Ext. TTL), and external Analog (Ext. Ana). The operating mode is changed by pressing the **Control knob**. The maximal driving current is set by turning **Control knob**. Use a fast/slow rotation for coarse/fine adjustment. The operating mode and the maximum driving current setting are independently adjusted for each channel.

Constant current (CW)

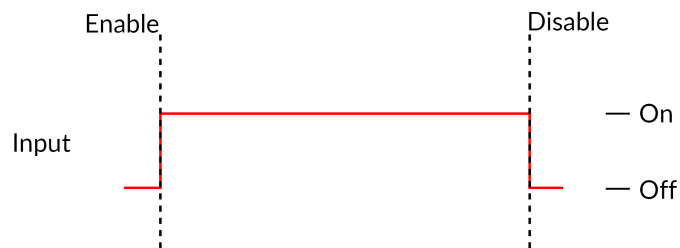

Figure 2.2: Constant Current Mode Driver Signal

When using the CW mode, the user simply sets the driving current applied to the light source. The light source is activated and an output beam will be visible as long as the driving current is above the minimum driving current (Fig. 2.2).

External TTL (TTL)

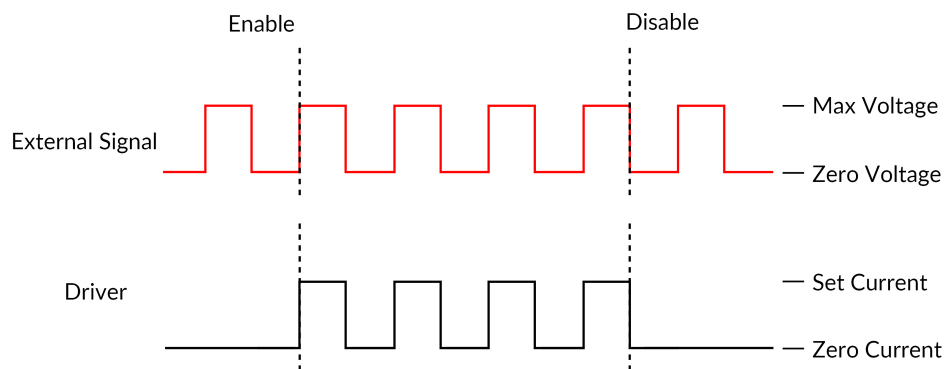

Figure 2.3: Driver Signal Response to External Source in External TTL Mode

In the External TTL mode, the driver is activated by an input TTL signal coming from an external device. This activation will follow the TTL pulse waveform. The driving current is set with the control knob, and is constant during each TTL activation pulse.

External Analog (Ext. Ana.)

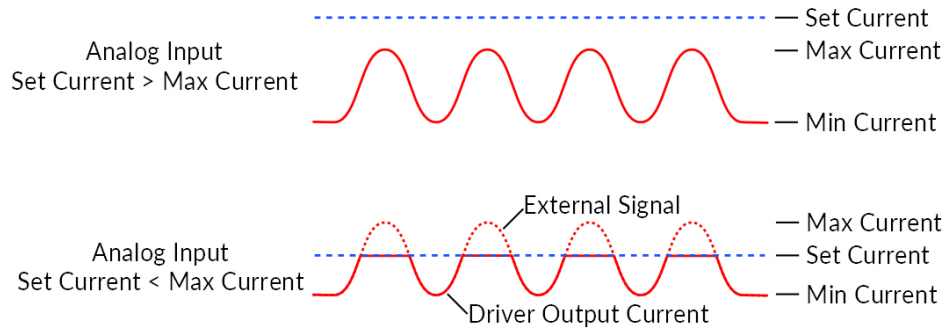

Figure 2.4: External analog pulse sequence behavior

The External Analog mode is similar to the External TTL, except that the driving current is proportional to the voltage applied on the BNC input connector (Fig. 2.4, top). On the input BNC, a maximum voltage signal corresponds to a maximum driver current. Should the current set on the light source be less than the maximum current, any voltage corresponding to a higher current will clip the output waveform (Fig. 2.4, bottom). To avoid any clipping of the output waveform, the maximum current setting must be equal to or greater than the corresponding maximum analog input voltage.

Doric Neuroscience Studio

3.1 Light Sources

Doric Light Sources can be controlled by the Doric Neuroscience Studio. These include *LED Modules*, *Laser Diode Modules* and *Ce:YAG Fiber Light Source*. The interface is separated into two main sections, **Control & settings** and the **Acquisition View**. Each light source driver has a number of **Channels**, each one controlling a light source of its given type. These channels, accessible using the **Add Channel** will be the first detailed.

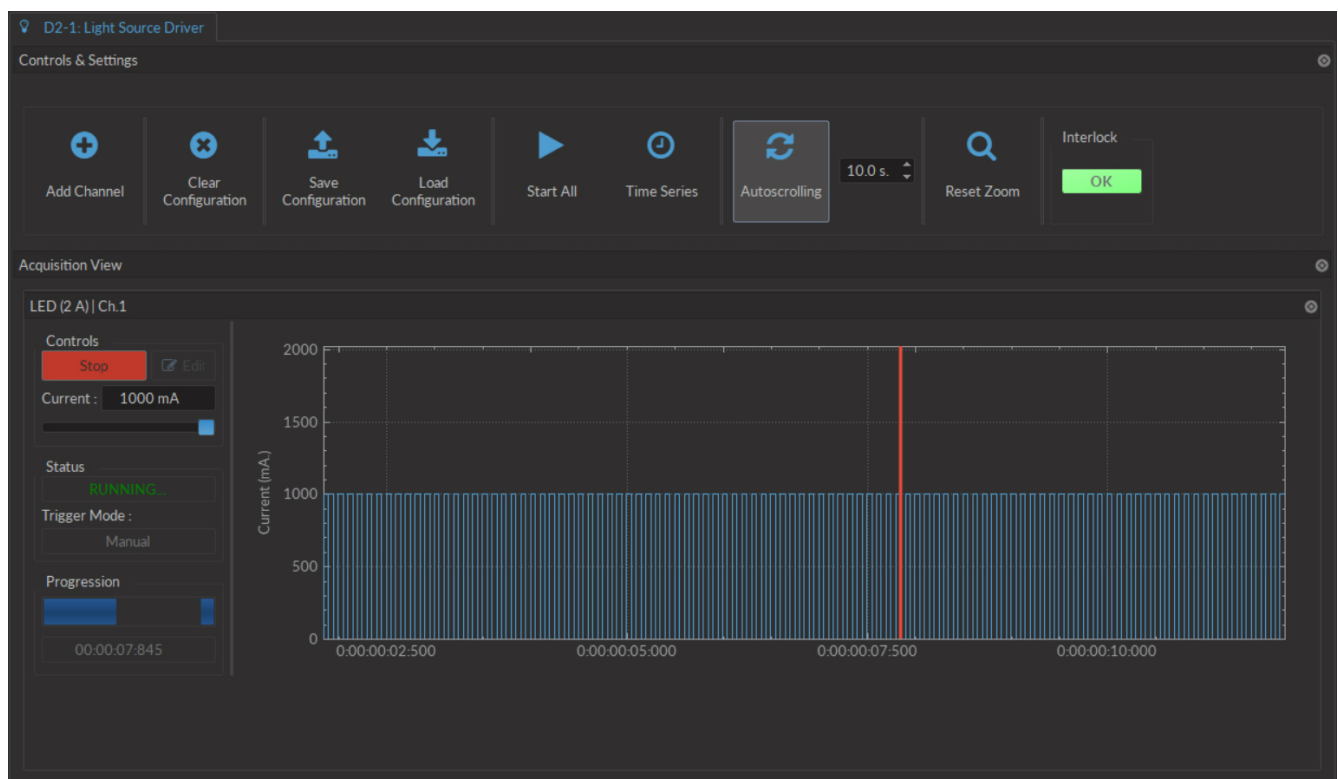

Figure 3.1: Light Source Driver Tab

3.1.1 Channels

Each light source driver is separated into a number of **Channels**. Each channel controls a single light source. While each channel can be controlled in **Stand-alone** mode by the driver, additional functions can be accessed for these channels when the driver is connected to the Doric Neuroscience Studio. These functions are used through the **Channel Configuration** window (Fig. 3.2).

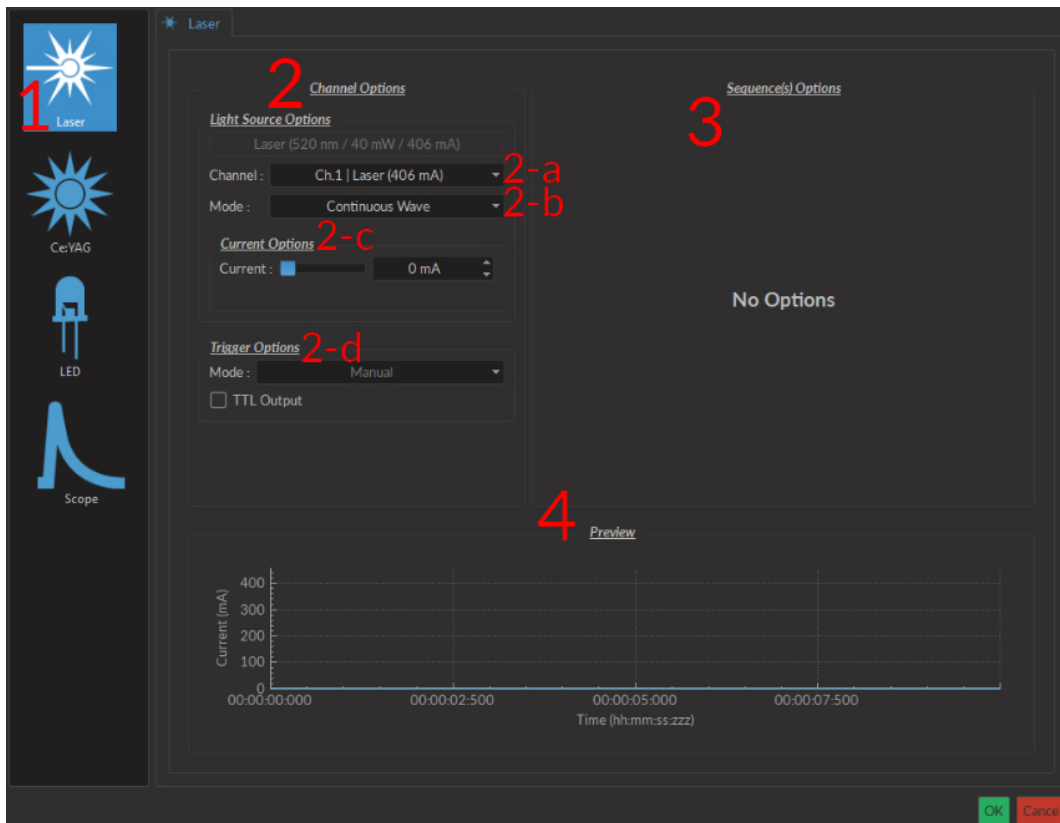

Figure 3.2: Light Source Channel Configuration Window

1. The **Channel Types** (Fig. 3.2) are displayed on the left side of the window. These include **Laser** light sources, **Ce:YAG** light sources and **LED** light sources, as well as the **Scope** to measure signal using the driver.
2. The **Channel Options** box (Fig. 3.2) includes **Light Source Options** and **Trigger Options** for the given channel.
 - a) The **Channel** (Fig. 3.2) drop-down list identifies which driver channel is currently being edited, assuming a driver with multiple channels.
 - b) The **Mode** (Fig. 3.2) drop-down list includes each possible driver mode. These are used to control the pulse sequences emitted by the light source. The options related to this mode are detailed with the **Sequence Options**.
 - c) The **Current Options** (Fig. 3.2) includes the slider used to control the current sent to the light source.
 - When using a **LED Driver** module, the **Overdrive** checkbox will appear. When selected, this allows the system to exceed the normal safe current limit of the light source. **THIS SHOULD ONLY BE USED WITH PULSED SIGNALS, AS IT CAN OTHERWISE DAMAGE THE LIGHT SOURCE.**
 - When using a **LEDD**, the **Low-Power** checkbox will appear. When selected, this allows reduced-power signaling for the same voltage. This mode is only available for **CLED** modules. This allows low-power signals to be more stable in time. The maximal current is reduced to one tenth of light source's normal maximal current. If the **BNC Output** is used, the voltage of the signal is proportional to the current passing through the light source, and not the voltage sent to it. For example, a driver with a normal maximum current of 2000 mA for a 5 V signal (400 mA/V) will have a maximum current of 200 mA for a 5 V signal (40 mA/V). The **BNC output** of the driver will still relate LED current with a 400 mA/V conversion factor.
 - d) The **Trigger Options** (Fig. 3.2) allow the selection of a number of trigger modes to activate a pulse sequence.
 - The **Manual** trigger mode is standard, and allows direction activation by the user.
 - The **Triggered** trigger mode is active when an input greater than 4 V is detected on the BNC input. Following input pulses will be ignored while the sequence is running. The sequence will restart with the arrival of the first input pulse after the sequence has finished.

- The **Gated** trigger mode is active as long as there is a high TTL signal (4 V or more) on the input modulation BNC. This signal comes from a different light source or device driver. When the TTL signal is low (0.4 V or less), the sequence stops and waits for another high TTL signal to continue.
- If the **TTL Output** option is checked, the output BNC channel can be used as a TTL generator. The monitoring signal will provide a TTL signal instead of an analog voltage output proportional to the LED current. The output will send out a 5 V signal whenever the input current is >0 mA. This can be used even if a light source is not connected.

3. The **Sequence options** box (Fig. 3.2) is where sequence options are defined depending on the mode. The **Continuous wave**, **External TTL** and **External Analog** modes have no additional sequence options.

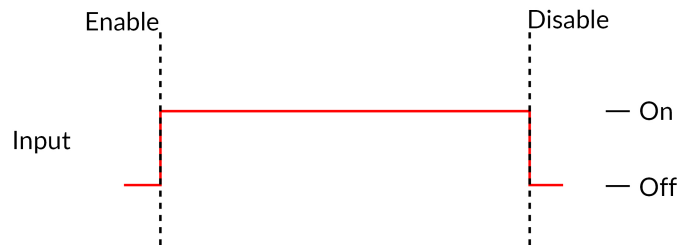

Figure 3.3: Constant Current Mode Driver Signal

a) The **Continuous Wave** mode (Fig. 3.3) produces a continuous signal at the chosen current. This mode can only be triggered manually. When this mode is active, the driver channel will show **CW** under **MODE**. This mode has no additional sequence options.

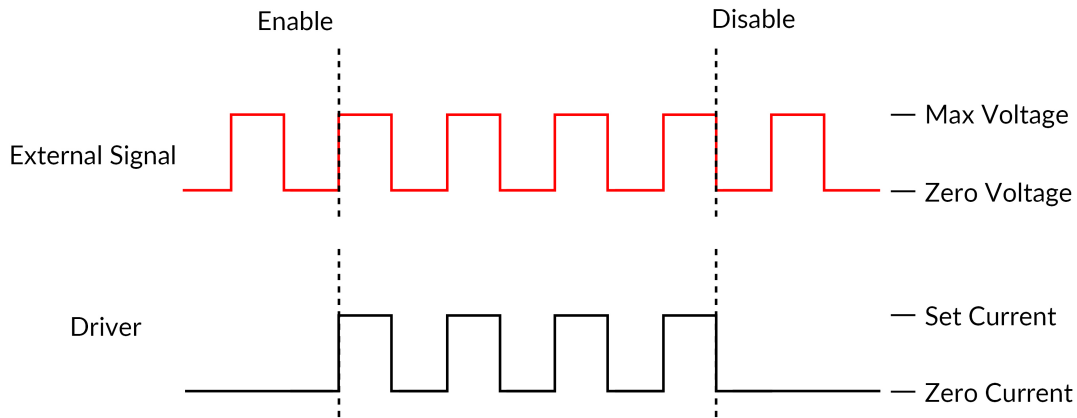

Figure 3.4: Driver Signal Response to External Source in External TTL Mode

b) The **External TTL** mode (Fig. 3.4) has the light source follow a TTL signal provided by an external source connected to the **BNC Input**. When this mode is active, the driver channel will show **TTL** under **MODE**. This mode has no additional sequence options.

c) The **External Analog** mode (Fig. 3.5) is similar to the External TTL, except that the current will be set by the voltage on the BNC input (Fig. 3.5, top). On the input BNC, a maximum voltage signal corresponds to a maximum driver current. Should the current set on the light source be less than the maximum current, any voltage corresponding to a higher current will clip the output waveform (Fig. 3.5, bottom). To avoid any clipping of the output waveform, the maximum current setting must be equal to or greater than the corresponding maximum analog input voltage. See the corresponding light source manual to find the voltage/current relationship. This mode has no additional sequence options.

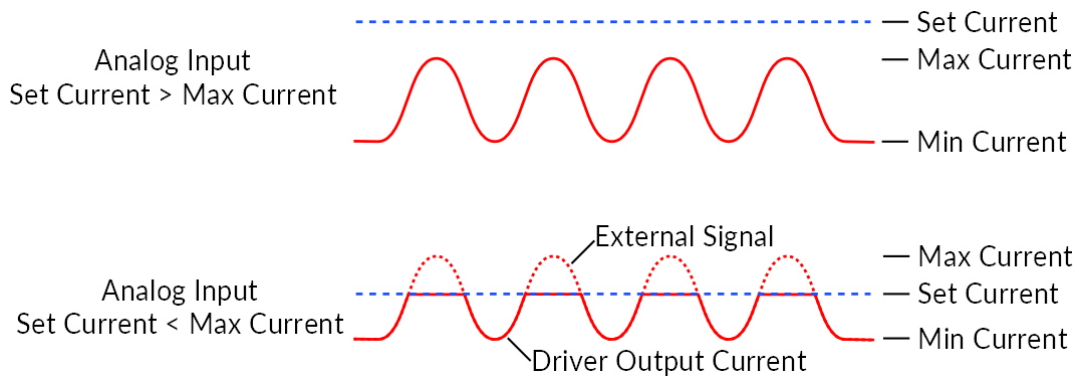

Figure 3.5: Driver and Light Source in External Analog Mode

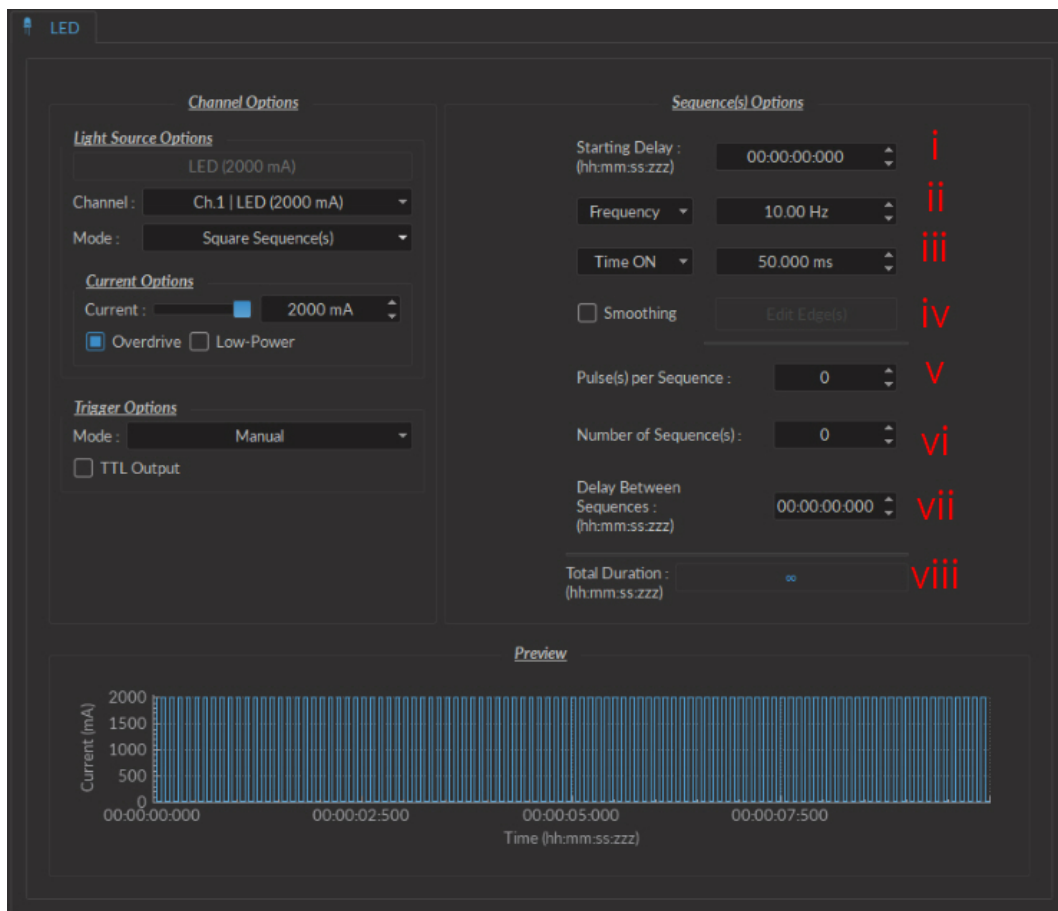

Figure 3.6: Light Source Channel Configuration Window, square sequence options

- d) The **Square sequences** mode has the light source follow an analog signal provided by an external source connected to the **BNC Input**.
- i. The **Starting Delay** (Fig. 3.6) sets the delay (in hh:mm:ss:zzz format) before the first pulse.
 - ii. The **Frequency/Period** (Fig. 3.6) sets the frequency (in Hz) or period (in ms) for the pulse sequence. For example, a signal at 10 Hz (frequency) will output one pulse every 100 ms (period), whereas a pulse sequence at 0.5 Hz (frequency) will output one pulse every 2000 ms (period).
 - iii. The **Time ON/Duty Cycle** (Fig. 3.6) sets the time (in ms) or the duty cycle (in %) for each pulse. The **Time ON** must be lower than $(1/\text{frequency}) + 0.005$ ms, while the **Duty cycle** must be below 100 %. These squares will appear red should an impossible **Frequency/time ON** be selected. Should the **Smoothing** option be selected, this feature becomes inaccessible.

- iv. The **Smoothing** option is used to change the pulse slope in square pulse sequences. The **Edit Edges** button opens the **Smoothing Edge(s)** window (Fig. 3.7).

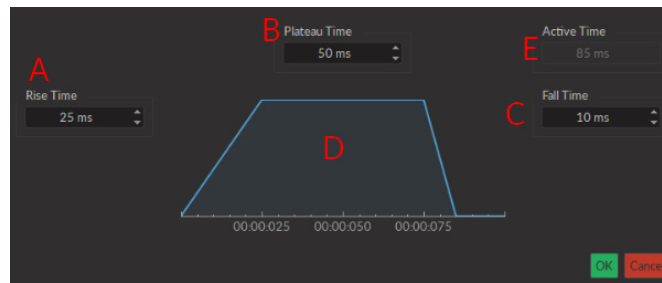

Figure 3.7: Light Source Smoothing Edge(s) Window

- A. The **Rise Time** box is used to define the duration to rise from 0 to the pulse maximum.
- B. The **Plateau Time** box is used to defined the duration the pulse is at its maximum value.
- C. The **Fall Time** box is used to define the duration to descend from the pulse maximum to 0.
- D. The **Pulse Graph** displays the pulse shape.
- E. The **Active Time** box displays the total duration of the pulse. While the **Smoothing** option is active, the **Time ON** is fixed at this value.
- v. The **Pulses per sequence** (Fig. 3.6) sets the number of pulses per sequence. If it is set to 0, the pulse will be repeated indefinitely.
- vi. The **Number of sequences** (Fig. 3.6) sets the number of times that the sequence will be repeated. If it is set to 0, the sequence will be repeated indefinitely.
- vii. The **Delay between sequences** (Fig. 3.6) sets the delay (in hh:mm:ss:zzz format) between each sequence if the **Number of Sequences** is greater than 1.
- viii. The **Total Duration** (Fig. 3.6) displays the total time of the experiment. The different values can be *Inf* for infinite, a valid time value or *Err* if the **Time ON** value is greater than 1/frequency.

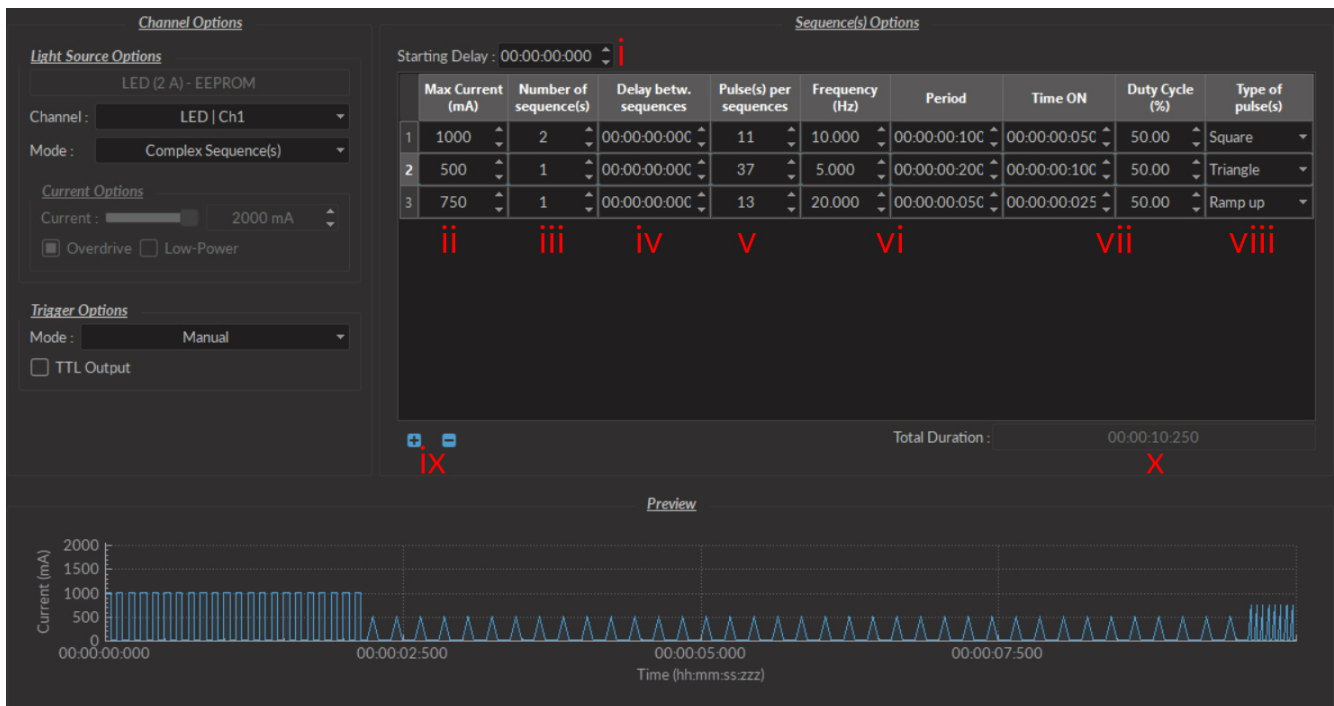

Figure 3.8: Complex Sequences Window

- e) The **Complex Sequences** mode mode allows the design of complex pulse sequences. Multiple sequences can be combined to create a more elaborate pulse sequence. These are displayed in a spreadsheet format.
- The **Starting Delay** (Fig. 3.8) sets the delay (in hh:mm:ss:zzz format) before the first pulse sequence.
 - The **Max Current** (Fig. 3.8) sets the maximum current (in mA) for the given sequence.
 - The **Number of sequences** (Fig. 3.8) sets the number of times that the sequence will be repeated, with a minimum of 1.
 - The **Pulses per sequence** (Fig. 3.8) sets the number of pulses per sequence, with a minimum of 1.
 - The **Delay between sequences** (Fig. 3.8) sets the delay (in hh:mm:ss:zzz format) between each sequence if the **Number of Sequences** is greater than 1.
 - The **Frequency/Period** (Fig. 3.8) sets the frequency (in Hz) or period (in ms) for the pulse sequence. These two values are linked, and when one is changed the other will adjust automatically. For example, a signal at 10 Hz (frequency) will output one pulse every 100 ms (period), whereas a pulse sequence at 0.5 Hz (frequency) will output one pulse every 2000 ms (period).
 - The **Time ON/Duty Cycle** (Fig. 3.8) sets the time (in ms) or the duty cycle (in %) for each pulse. These two values are linked, and when one is changed the other will adjust automatically. The **Time ON** must be lower than $(1/\text{frequency})+0.005$ ms, while the **Duty cycle** must be below 100 %.

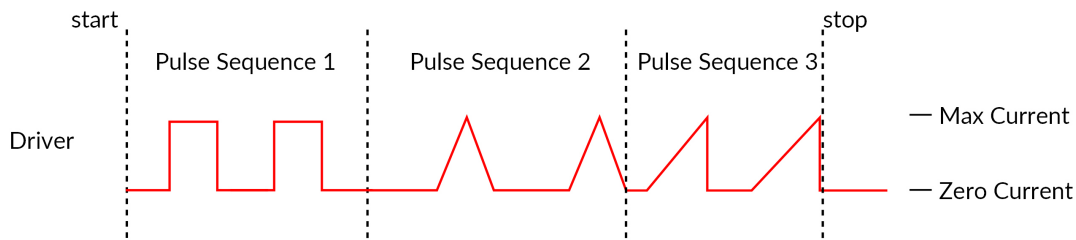

Figure 3.9: Internal Complex Mode Pulse Sequences

- The **Types of pulses** (Fig. 3.8) sets the pulse type. Pulses can be **Square**, triangular (**Triangle**), **Ramp up** **Ramp down** or **Delay** (Fig. 3.9). The **Delay** pulse type is used to create a delay between different sequence
 - The **Sequence controls** (Fig. 3.8) allow the addition (+) or removal (-) of sequences to the spreadsheet.
 - The **Total Duration** (Fig. 3.8) displays the total time of the experiment. The different values can be *Inf* for infinite, a valid time value or *Err* if the **Time ON** value is greater than $1/\text{frequency}$.
- f) The **Scope** mode allows the measurement of electrical signal using the driver (Fig. 3.10). The signal is received by the Input BNC of the chosen channel on the light source driver.

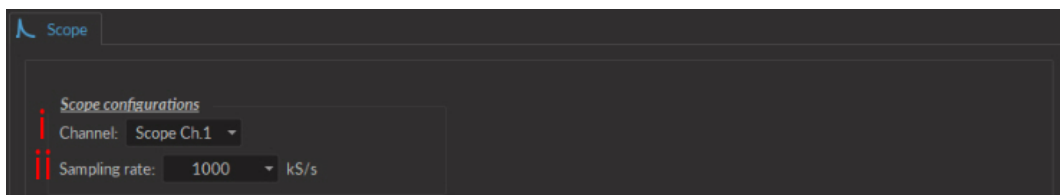

Figure 3.10: Scope

- The **Channel** drop-down list indicated which driver channel will be used to receive signal. The chosen can be used to drive a light source while serving as a scope.
 - The **Sampling Rate** drop-down list allows the selection of the rate (in kilosamples per second) at which measurements are taken.
4. The **Preview** box (Fig. 3.2) displays a preview of the chosen sequence while in the **Continuous Wave**, **Square Sequences** and **Complex Sequences** mode.

3.1.2 Control & Settings

The **Control & settings** sections is used to control the light source. It includes the following elements.

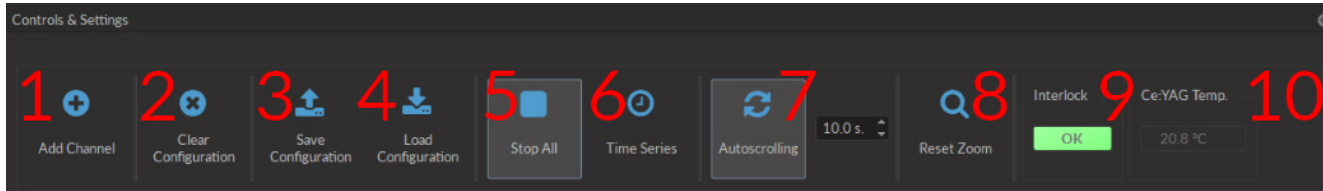

Figure 3.11: Control & Settings

1. The **Add channel** button (Fig. 3.11) opens the **Channel Configuration** window 3.2. See section 3.1.1 for more details.
2. The **Clear Configuration** button (Fig. 3.11) clears all configuration channels. Cleared channels cannot be recovered unless previously saved.
3. The **Save configuration** button saves all currently configured channels in **.doric** format.
4. The **Load configuration** button loads a file in **.doric** format that contains a previously saved set of configured channels.
5. The **Start All** button (Fig. 3.11) starts all currently configured channels.
6. The **Time Series** button opens the **Time Series** window. This tool allows all channels to share the same timing.

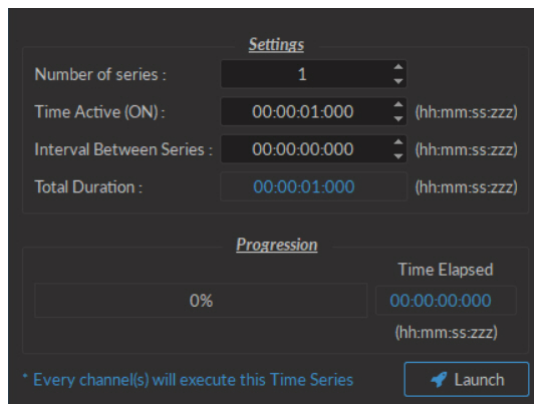

Figure 3.12: Control & Settings, Time Series Window

- The **Number of series** (Fig 3.12) sets the number of times that the sequence will be repeated, with a minimum of 1.
 - The **Time Active** sets the duration of each series in hh:mm:ss:zzz format. If the **Time series** is used in combination with a sequence, the **Time Active** should be greater than the sequence **Total Time** If the **Time Active** is shorter, the sequence will be stopped after the **Time Active**.
 - The **Interval between series** sets the duration between each series in hh:mm:ss:zzz format.
 - The **Total Duration** displays the total duration of the sequence in hh:mm:ss:zzz format.
 - The **Progression** bar displays the progression of the sequence in %, while the **Time Elapsed** counter displays the progression in hh:mm:ss:zzz format.
 - The **Launch** button starts the sequence.
7. The **Autoscrolling** button activates the autoscroll function. When active, the **Graph** in the **Acquisition View** will follow a section as wide as the time defined beside the button.

8. The **Reset Zoom** button resets the axes in the **Graph** to their standard values.
9. The **Interlock** indicator displays OK when the interlock is correctly connected, and DISCONNECTED when disconnected.
10. The **Ce:YAG Temp** indicator displays the temperature of the *Ce:YAG source* in real time. This indicator will only appear when a *Ce:YAG driver* is connected to the computer. Should the temperature be too high the temperature will appear in **red**. Should the temperature be too low, the temperature will appear in **blue**.

3.1.3 Experiment View

The **Experiment View** box is used to display information related to the usage of each channel. This section allows limited control of the light source while it is active.

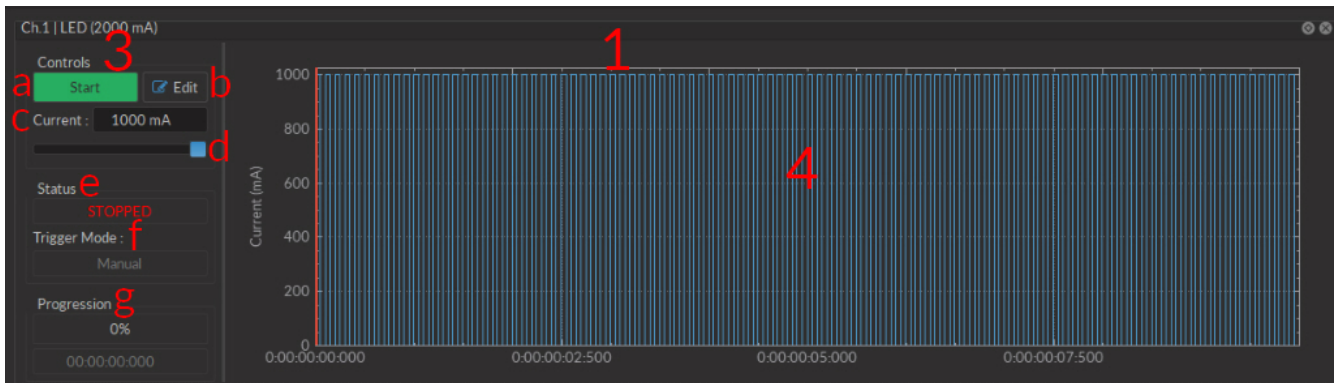

Figure 3.13: Experiment View, Light Source Channel

1. The **Light Source Channel** box (Fig. 3.13) contains all elements related to a single light source channel.
2. The **Scope Channel** box (Fig. 3.14) is used to control and configure an active **Scope**.

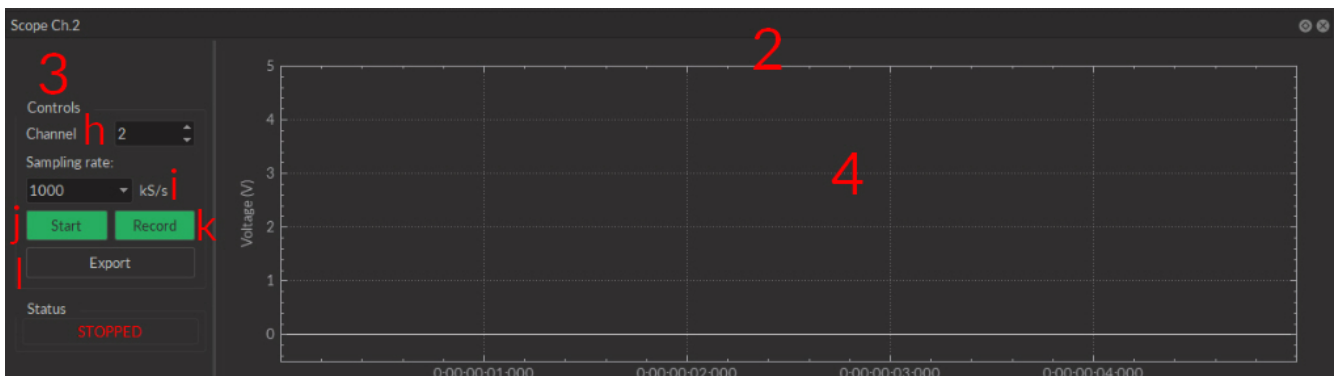

Figure 3.14: Experiment View, Scope Channel

3. The **Controls View** displays all elements to control/configure the channel.
 - a) The **Start/Stop** button activates/deactivates the light source connected to the **Light Source Channel**.
 - b) The **Edit** button opens the **Channel configuration** window to edit the pulse sequence. This button is only accessible when the channel is deactivated.
 - c) The **Current Box** box allows the current to be changed exactly (in mA).
 - d) The **Current Slider** allows the light source current to be adjusted.
 - e) The **Status** box displays the status of the channel (**Light source** or **Scope**). The **Status** will display **RUNNING...** when active and **STOPPED** when deactivated.

- f) The **Trigger Mode** of the light source is displayed in this box.
 - g) The **Progression** box displays the progression of the pulse sequence. The advancement of the sequence is displayed % on the **Progression bar**, and in hh:mm:ss:zzz format on the **Time Elapsed** box.
 - h) The **Channel** drop-down list is used to choose the channel used as a scope.
 - i) The **Sampling Rate** drop-down list allows the selection of the rate (in kilosamples per second) at which measurements are taken.
 - j) The **Start** scope channel button activates a live measurement sequence. Important measurements should not be made as a live measurement, as these only conserve a small amount (60 s) of data.
 - k) The **Record** scope channel button starts a recorded measurement sequence.
 - l) The **Export** scope channel button allows the recording of a live measurement sequence on the scope.
4. The **Graph View** displays either a preview of the pulse sequence for **Light Source Channels** or the received signal for the **Scope Channel**.

Specifications

Table 4.1: *Electronic and Software Specifications*

SPECIFICATION	VALUE	NOTE
Power supply	110 - 240 VAC; 50 - 60 Hz	Power supply adapter included
DC power supply	12 VDC	20 W (1-ch, 2-ch), 60 W (4-ch)
Dimensions (L x H x D)		
1-channel model	17,5 cm x 5,0 cm x 10,5 cm	Including aperture
2-channel model	23,4 cm x 5,0 cm x 10,5 cm	Including aperture
4-channel model	35,0 cm x 5,0 cm x 10,5 cm	Including aperture
TTL input voltage	0 to +5 V	Min Hi Level: 2.8 V; Max Low Level: 2.3 V
Analog input voltage	400 mA/V light source current	Standard 1 A LED
	40 mA/V light source current	Low power mode enabled
BNC output voltage	2.5 V/A	
Maximum LED current range	200, 2000 mA	
Maximum forward voltage to LED	7 V	
Minimum LED current	2.5 mA	Low power mode enabled
Display current accuracy	2% @ maximum rated current	Error increases at lower current.
Current adjustment steps	1 mA	
Rise/Fall time	< 10 μ sec	Typical
Modulation minimum frequency	0.01 Hz ¹	Internal complex mode : 0.000054 Hz
Modulation maximum frequency	50 kHz	-3 dB attenuation
Minimum ON or OFF time	0.005 ms ¹	Internal complex mode : 2 ms
Maximum ON or OFF time	100 s ¹	Internal complex mode : 5 h
Maximum pulses per sequence	16.68 millions ¹	Internal complex mode : 65 535
Maximum number of sequences	4.2 billions ¹	Internal complex mode : 65 535
Minimum step increments	39 μ sec	Internal complex mode only
Number of steps per period	128	Internal complex mode only
Scope acquisition speed	10 kS/s	Single channel

¹For all operation modes, except the internal complex mode

Table 4.2: *Optical Specifications*

SPECIFICATION	VALUE	NOTE
Output NA	0.55	NA of up to 0.63 NA will slightly increase power;
Output optical fiber core diameter	<960 μm	Power scales up to this core diameter

Annex 1: Safety Features

5.1 Safety Labels

The laser class labels are provided with the system and the laser aperture is clearly identified by laser warning label and/or the text *LASER APERTURE*.



Figure 5.1: Safety Labels

5.2 Activation Safety Features

The drivers for all Doric Lenses light sources come with a number of safety features. These are built into the driver circuits, as shown in the block diagram (Fig. 5.2).

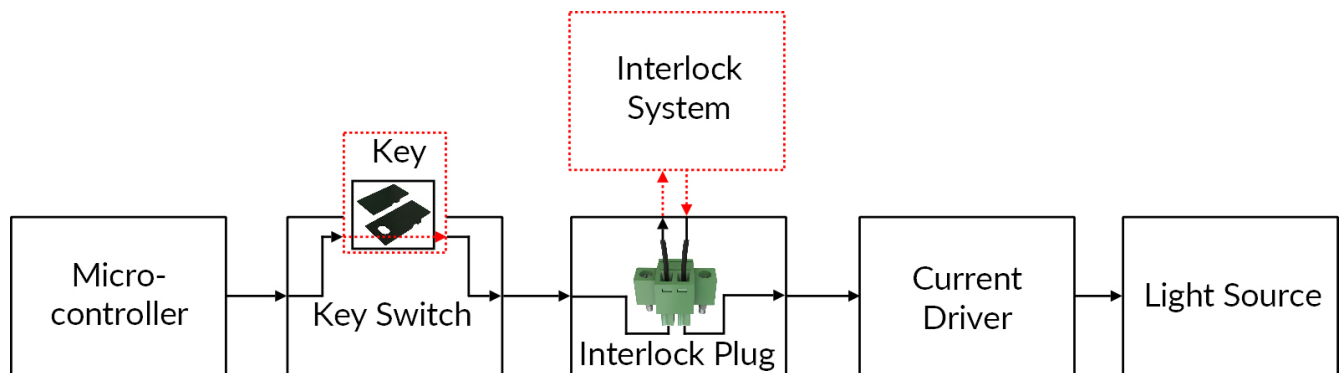

Figure 5.2: Safety feature block diagram

- The **Micro-controller**, **Key Switch**, **Interlock Plug** and **Current Driver** are connected in series. This means that if any single safety feature is not properly in place, the light source cannot be activated.
- The **Micro-controller** is used to control the light source driver.
- The **Key Switch** (Safety feature 1) (Fig. 5.3a), located on the left side of the driver, is required to activate any light source. If removed, no data can be sent from the micro-controller to the **Current Driver**.
- The **Interlock plug** (Safety feature 2) (Fig. 5.3b) is used to integrate the driver into an **Interlock Circuit**.

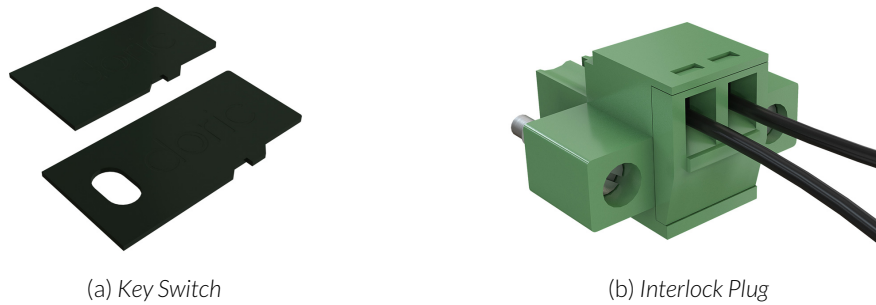

Figure 5.3: Safety Feature Elements

- The **Interlock Plug** comes with a small wire short-circuiting it. This wire must be removed before integrating it into an **Interlock Circuit**.
- Connect the **Interlock circuit** in series with the **Interlock Plug** so the circuit may function properly.
- The **Current Driver** sends current to any connected light source. If the **Key** is absent or the **Interlock Plug** has an open circuit, it cannot receive signals from the micro-controller, preventing it from sending out current.

5.3 Emission Indicator

For light sources emitting invisible laser radiation, a dedicated LED indicator is ON when the driver is outputting an electrical current. When the driver is outputting current, the light source will emit light from the aperture.

Support

6.1 Maintenance

The product does not require any maintenance. Do not open the enclosure. Contact Doric Lenses for return instructions if the unit does not work properly and needs to be repaired.

6.2 Warranty

This product is under warranty for a period of 12 months. Contact Doric Lenses for return instructions. This warranty will not be applicable if the unit is damaged or needs to be repaired as a result of improper use or operation outside the conditions stated in this manual. For more information, see our [Website](#).

6.3 Contact us

For any questions or comments, do not hesitate to contact us by:

Phone 1-418-877-5600

Email sales@doriclenses.com



广州虹科电子科技有限公司
邮箱 : sales@hkaco.com/info@hkaco.com
电话: 400 999 3848
官网: www.hophotonix.com